

BCMA Series
Common Mode Filters For Automotive Power Line
Size 7060



FEATURES

- Exclusive square type closed magnetic core designed as an exclusive core is used, so it can be small while maintaining the same features.
- Low profile design makes it optimal for surface mounting.
- Excellent impedance characteristics, making it great for suppressing common mode noise.
- Maximum 15A can be used in 125°C environments.
- Operating temperature range: -40 to +125°C(including self-temperature rise)
- AEC-Q200 qualified
- Quantity: 1500pcs

APPLICATIONS

- Measures against common mode noise in power lines for various DC power lines, multimedia devices, and various electronic devices

Dimensions: [mm]

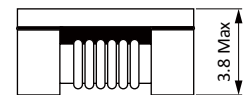
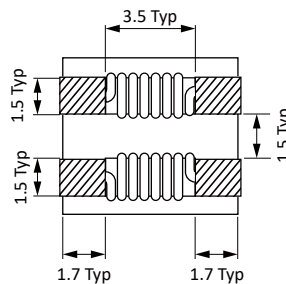
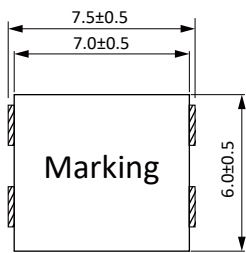

Land Pattern: [mm]

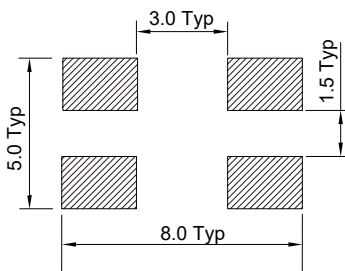

Electrical Properties:

Part No	Z @ 100 MHz Min. (Ω)	Z @ 100 MHz Typ. (Ω)	I _R Max. (A)	R _{DC} Max. (mΩ)	V _{DC} Max. (Volts)	IR Min. (MΩ)
BCMA7060-700Y	40	70	15	5	80	10
BCMA7060-141Y	100	140	9.0	10	80	10
BCMA7060-301Y	225	300	5.0	10	80	10
BCMA7060-501Y	400	500	5.0	10	80	10
BCMA7060-701Y	500	700	4.0	15	80	10
BCMA7060-102Y	800	1000	3.0	17	80	10
BCMA7060-132Y	910	1300	3.0	20	80	10
BCMA7060-272Y	2000	2700	1.0	63	80	10
BCMA7060-302Y	2500	3000	0.9	75	80	10

Temperature Rise Current: The actual value of DC current when the temperature rise is $\Delta T=40^{\circ}\text{C}$

Typical Electrical Characteristics:

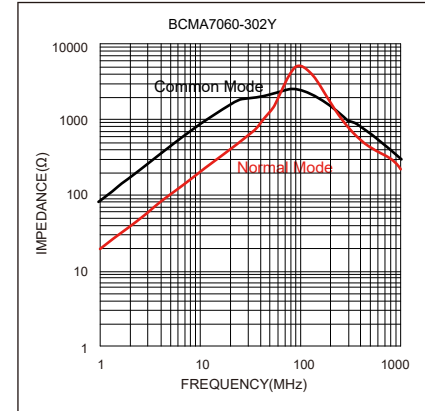
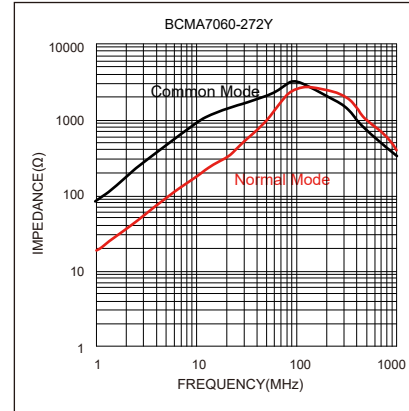
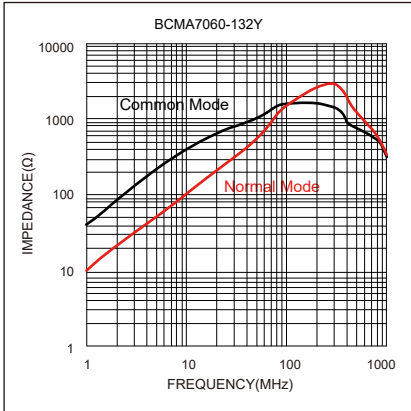
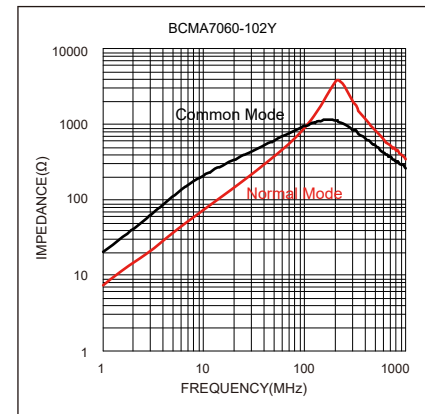
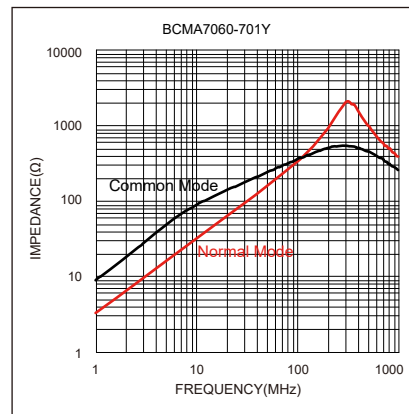
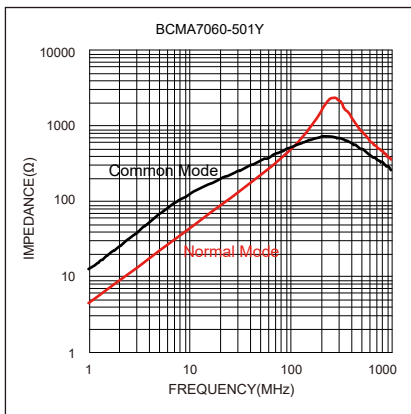
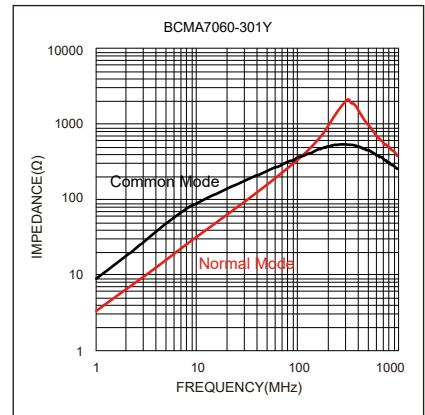
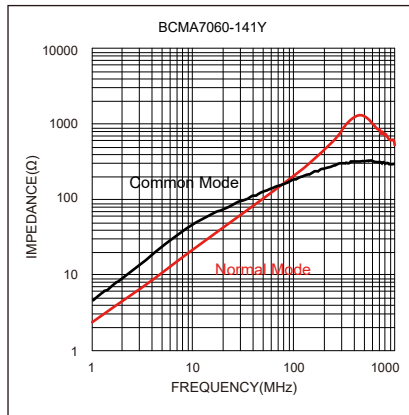
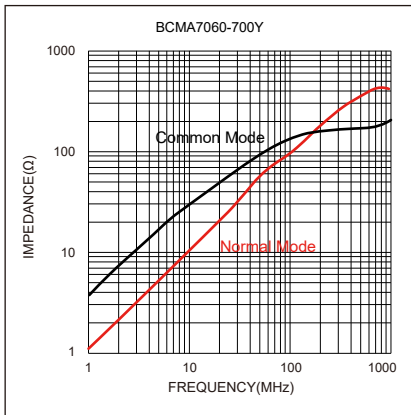

Soldering Reflow:

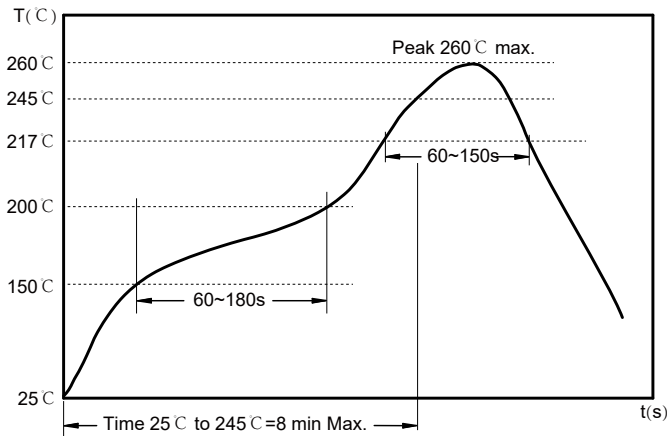

Preheat condition: 150 ~200 °C / 60~180 sec.
 Allowed time above 217 °C: 60~150 sec.
 Max temperature: 260 °C.
 Max time at max temperature: 10 sec.
 Allowed Reflow time: 3x max.

Packaging Information:

Tape Dimension :

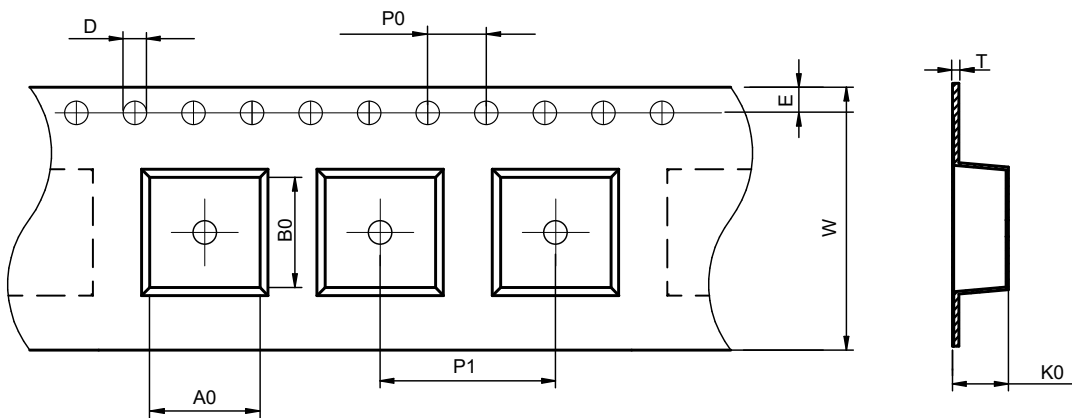

Series	A0 (mm)	B0 (mm)	D (mm)	P0 (mm)	P1 (mm)	W (mm)	K0 (mm)	E (mm)	T (mm)
BCMA7060	6.25±0.1	7.7±0.1	1.5±0.1	4.0±0.1	12.0±0.1	16.0±0.3	3.6±0.1	1.75±0.1	0.40±0.05

Peel force of top cover tape:

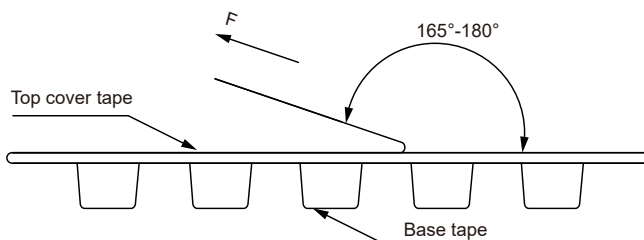

The peel force of top cover tape shall be between 0.10 to 1.17 N

Product Marking:

Marking	Printing (Impedance)
---------	----------------------

Reel Dimension: [mm]

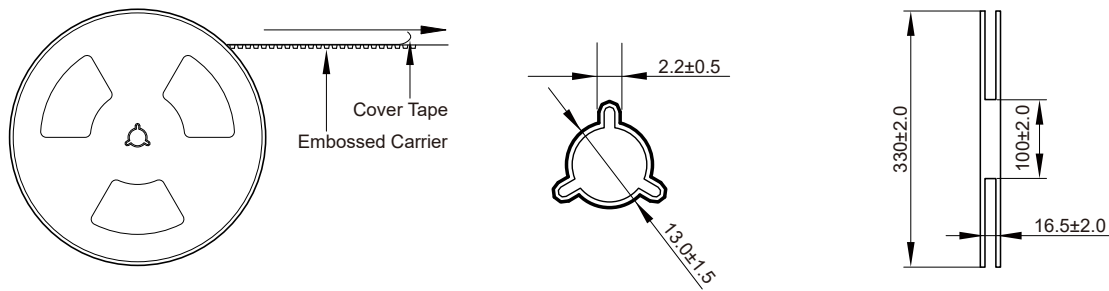

Packaging Quantity:

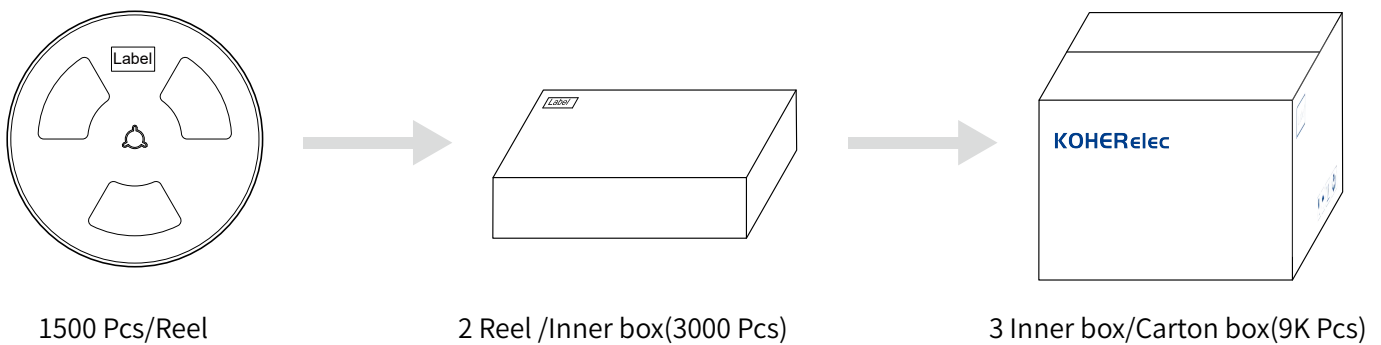

Cautions and Warnings:

Storage Conditions:

- The storage period is within 12 months after the completion of production. Be sure to follow the storage conditions (temperature: -5 to 35°C, humidity: 75% RH Max).If the storage period elapses, the soldering of the terminal electrodes may deteriorate.The warranty period is one year.
- Product should not be exposed to environment with high temperature, high humidity, dust, corrosive gas and etc.
- Products should be handled with care to avoid damage or contamination from perspiration and skin oils.
- Please always handle products carefully to prevent any damage caused by dropping down or inappropriate removing.

Operation Instructions:

- Self heating (temperature increase) occurs when the power is turned ON, so the tolerance should be sufficient for the set thermal design.
- Before soldering, be sure to preheat components.The preheating temperature should be set so that the temperature difference between the solder temperature and chip temperature does not exceed 150°C.
- Soldering corrections after mounting should be within the range of the conditions determined in the specifications.If overheated, a short circuit, performance deterioration, or lifespan shortening may occur.
- Generally, Koher might not be familiar with either customer's specific application or actual requests as customer does.As a result customer shall be responsible for checking and confirming whether Koher product with the performance described in the product specification is suitable for using in customer's particular application or not.