

**BCMA Series**  
Common Mode Filters For Automotive Signal Line  
Size 9040



**FEATURES**

- Suppression of asymmetrical interference coupled in on lines, whereas data signals up to some MHz can pass unaffectedly
- Low profile design makes it optimal for surface mounting Excellent impedance characteristics, making it great for suppressing common mode noise.
- Operating temperature: -40°C to +125°C
- AEC-Q200 qualified
- Quantity: 1500pcs

**APPLICATION**

- CAN bus, FlexRay system

**Dimensions: [mm]**

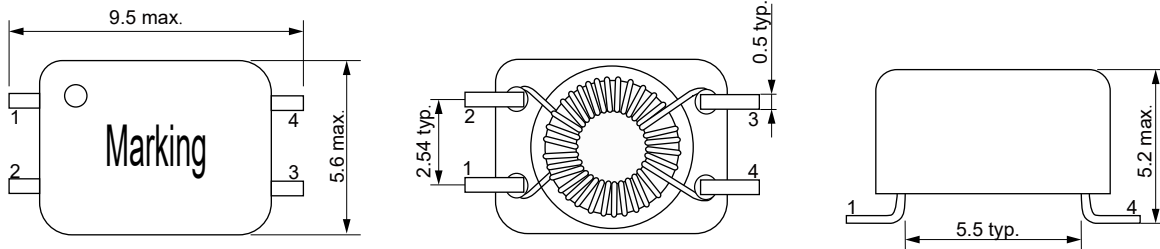

**Schematic:**



**Land Pattern: [mm]**

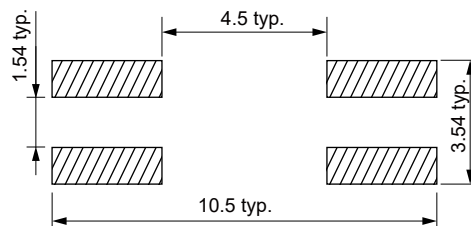

Electrical Properties:

Part No	Inductance @100KHz/0.1V (μH)	Tolerance	Leakage Inductance @100KHz/0.1V (μH) Typ. 1-4(2-3 short)	Temperature Rise Current (A)	DC Resistance Max. (mΩ)	Rated voltage Max. (V)	Frequency Range (MHz)
BCMA9040-110Y	11	+50/-30%	0.08	0.5	120	50	20-300
BCMA9040-250Y	25	+50/-30%	0.15	0.5	200	50	20-150
BCMA9040-510Y	51	+50/-30%	0.20	0.5	300	50	20-100
BCMA9040-101Y	100	+50/-30%	0.25	0.5	100	50	3-20
BCMA9040-471Y	470	+50/-30%	0.28	0.5	280	50	2-15
BCMA9040-102Y	1000	+50/-30%	0.28	0.5	300	50	1-10
BCMA9040-222Y	2200	+50/-30%	0.29	0.5	400	50	0.8-5
BCMA9040-472Y	4700	+50/-30%	0.30	0.2	700	50	0.5-3

Temperature Rise Current: The actual value of DC current when the temperature rise is  $\Delta T=40^{\circ}C$

Typical Electrical Characteristics:

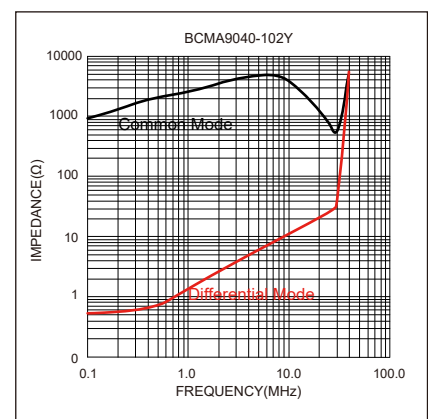
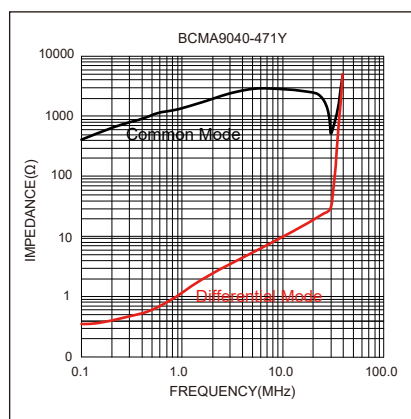
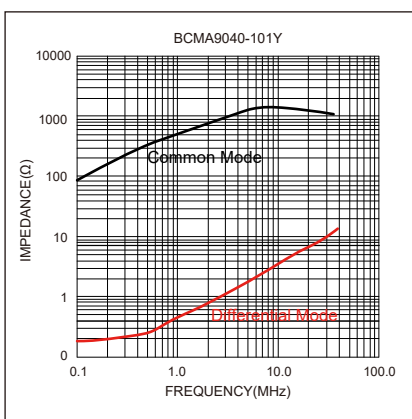
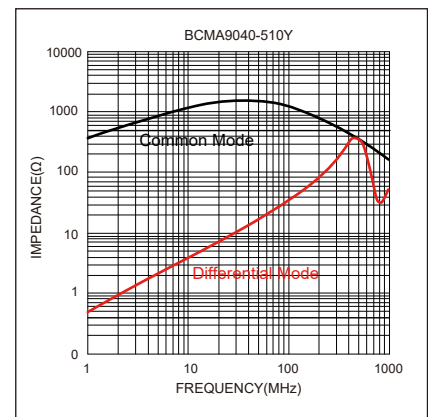
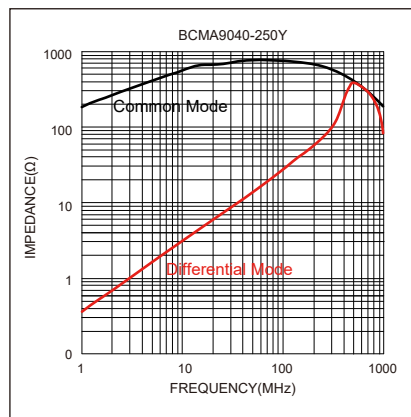
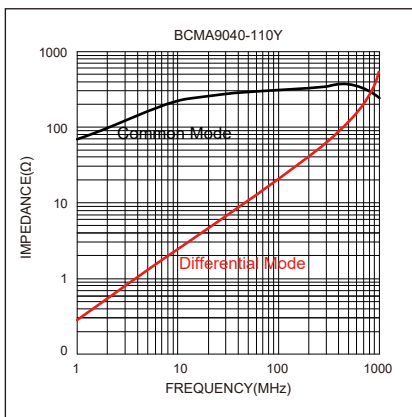

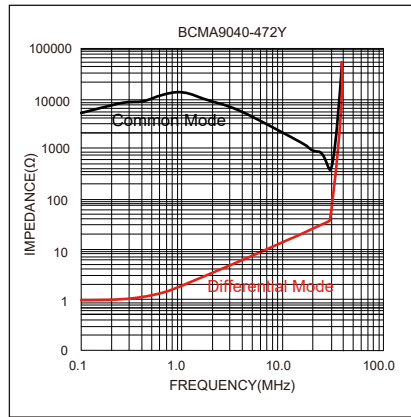
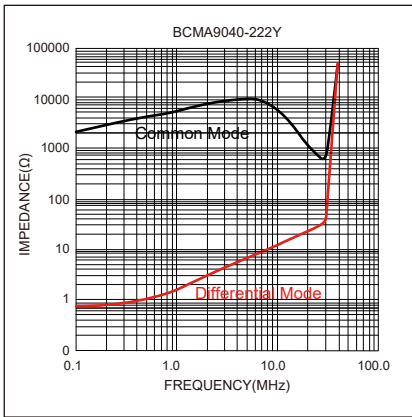

Soldering Reflow:

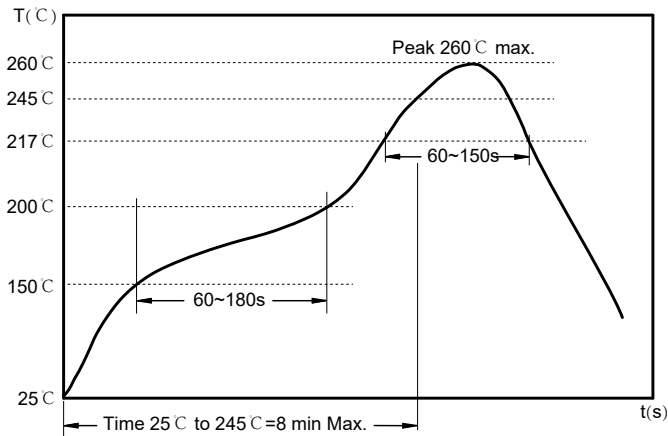

Preheat condition: 150 ~200 °C / 60~180 sec.  
 Allowed time above 217 °C: 60~150 sec.  
 Max temperature: 260 °C.  
 Max time at max temperature: 10 sec.  
 Allowed Reflow time: 3x max.

Packaging Information:

Tape Dimension :

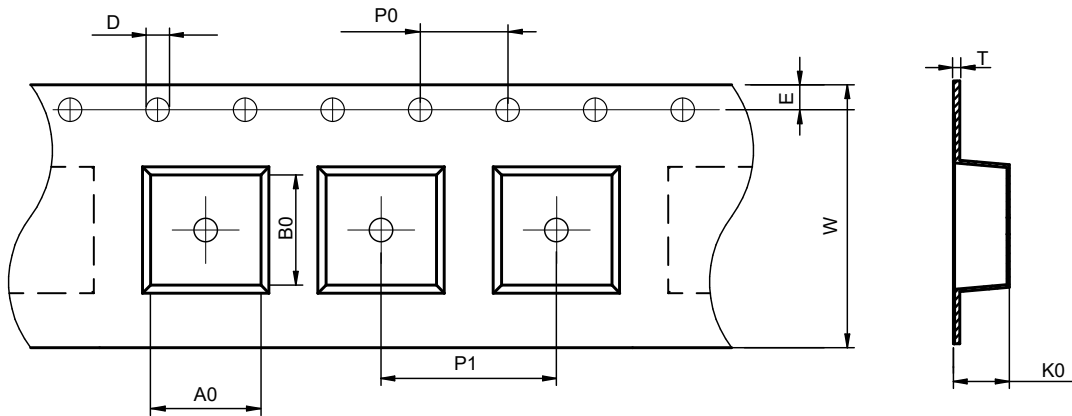

Series	A0 (mm)	B0 (mm)	D (mm)	P0 (mm)	P1 (mm)	W (mm)	K0 (mm)	E (mm)	T (mm)
BCMA9040	5.85±0.1	9.60±0.1	1.5±0.1	4.0±0.1	8.0±0.1	16.0±0.3	4.92±0.1	1.75±0.1	0.50±0.05

Peel force of top cover tape:

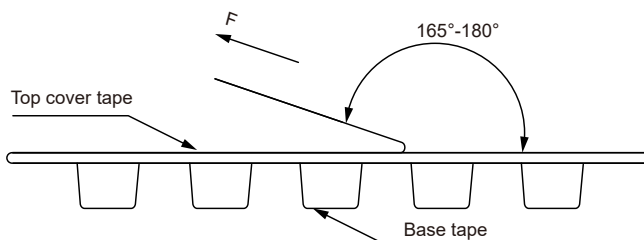

The peel force of top cover tape shall be between 0.10 to 1.17 N

Product Marking:

Marking	Dot+Printing (Inductance)
---------	---------------------------

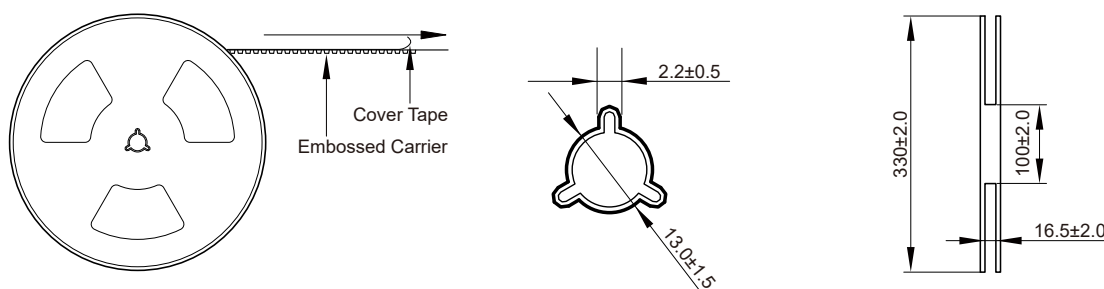
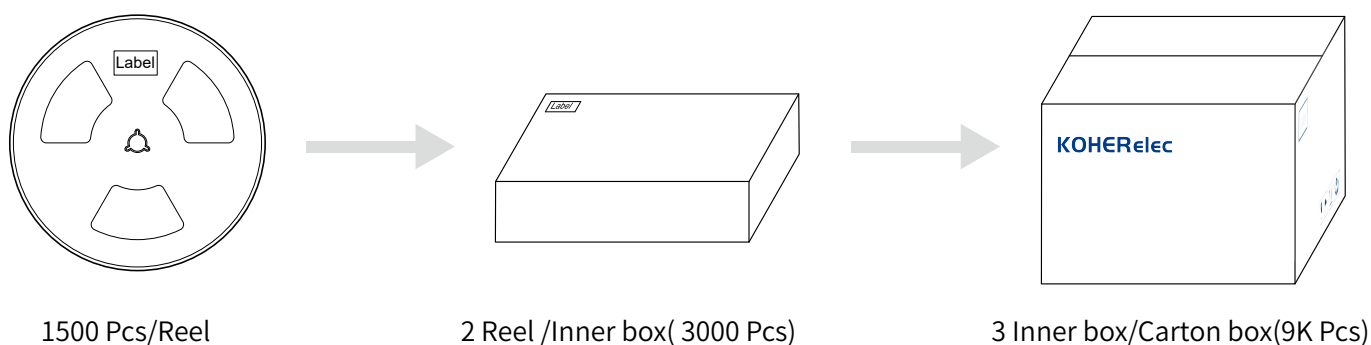
**Reel Dimension: [mm]**

**Packaging Quantity:**

**Cautions and Warnings:**
**Storage Conditions:**

- The storage period is within 12 months after the completion of production. Be sure to follow the storage conditions (temperature: -5 to 35°C, humidity: 75% RH Max). If the storage period elapses, the soldering of the terminal electrodes may deteriorate. The warranty period is one year.
- Product should not be exposed to environment with high temperature, high humidity, dust, corrosive gas and etc.
- Products should be handled with care to avoid damage or contamination from perspiration and skin oils.
- Please always handle products carefully to prevent any damage caused by dropping down or inappropriate removing.

**Operation Instructions:**

- Self heating (temperature increase) occurs when the power is turned ON, so the tolerance should be sufficient for the set thermal design.
- Before soldering, be sure to preheat components. The preheating temperature should be set so that the temperature difference between the solder temperature and chip temperature does not exceed 150°C.
- Soldering corrections after mounting should be within the range of the conditions determined in the specifications. If overheated, a short circuit, performance deterioration, or lifespan shortening may occur.
- Generally, Koher might not be familiar with either customer's specific application or actual requests as customer does. As a result customer shall be responsible for checking and confirming whether Koher product with the performance described in the product specification is suitable for using in customer's particular application or not.