

MDTE Series

Wire Wound Molded SMD Power Inductors Size 20161A

FEATURES

- Soft saturation
- High current, low DCR, high efficiency
- Very low acoustic noise and very low leakage flux noise
- High reliability
- 100% Lead(Pb)-Free and RoHS compliant
- Operating temperature -40~+125 °C (Including self - temperature rise)
- Quantity: 3000pcs

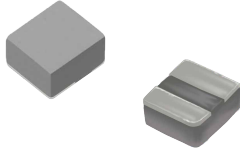

APPLICATION

- Note PC power system, incl. IMVP-6
- DC/DC converter

Dimensions: [mm]

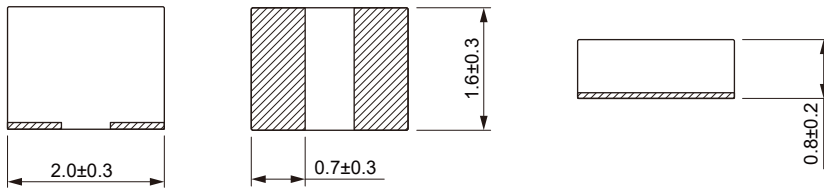

Land Pattern: [mm]

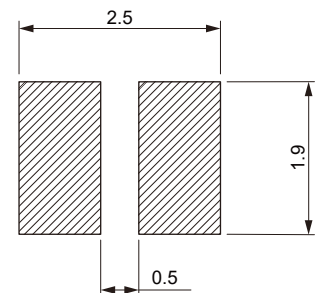

Electrical Properties:

Part No	Inductance @ 1MHz/1V (μH)	Tolerance	Saturation Current Typ. (A)	Saturation Current Max. (A)	Temperature Rise Current Typ. (A)	Temperature Rise Current Max. (A)	DC Resistance Max. (mΩ)
MDTE20161A-R10M	0.10	±20%	9.0	8.4	8.5	8.0	14
MDTE20161A-R15M	0.15	±20%	8.7	8.0	7.6	7.0	16
MDTE20161A-R24M	0.24	±20%	7.3	7.0	6.8	6.2	18
MDTE20161A-R33M	0.33	±20%	7.0	6.5	6.5	6.0	20
MDTE20161A-R47M	0.47	±20%	6.3	5.5	6.0	5.5	22
MDTE20161A-R68M	0.68	±20%	5.2	4.7	5.0	4.5	31
MDTE20161A-1R0M	1.00	±20%	4.8	4.2	4.0	3.7	46
MDTE20161A-1R5M	1.50	±20%	3.5	3.1	3.4	3.0	96
MDTE20161A-2R2M	2.20	±20%	3.0	2.8	2.8	2.5	138
MDTE20161A-3R3M	3.30	±20%	2.3	2.0	1.7	1.5	170
MDTE20161A-4R7M	4.70	±20%	2.0	1.8	1.6	1.4	220

Saturation Current will cause L to drop approximately 30%

Temperature Rise Current: The actual value of DC current when the temperature rise is $\Delta T=40^{\circ}\text{C}$

Typical Electrical Characteristics:

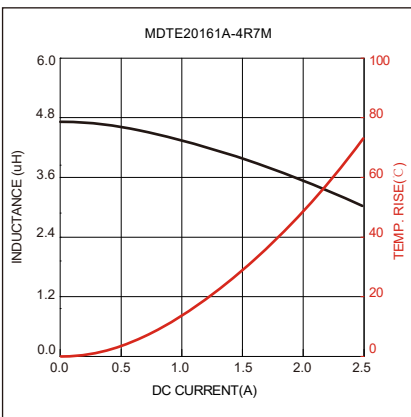
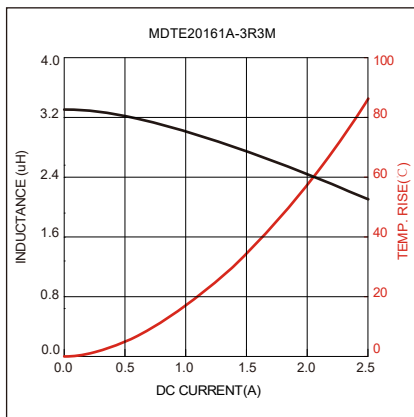
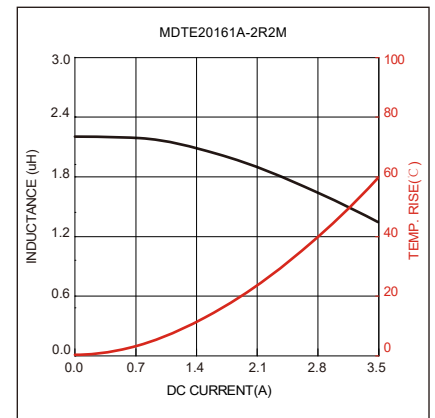
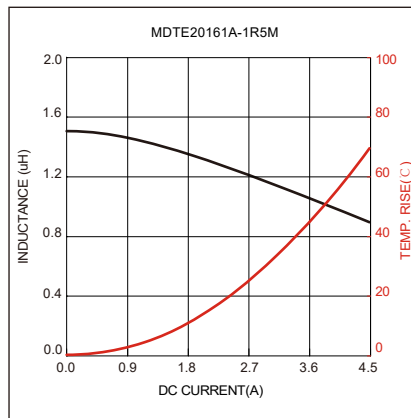
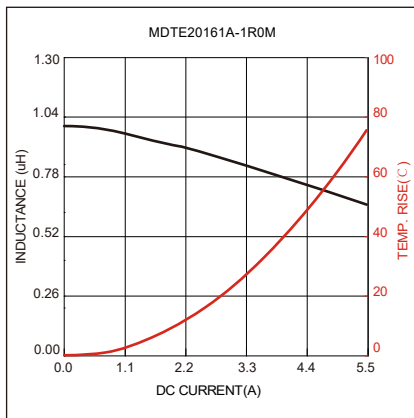
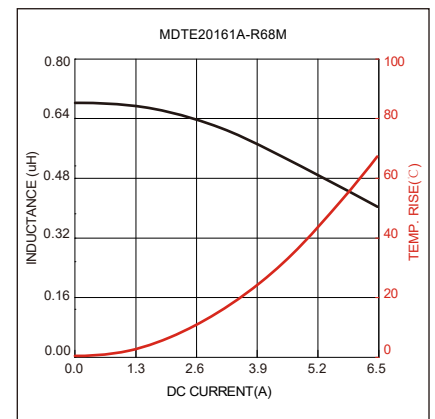
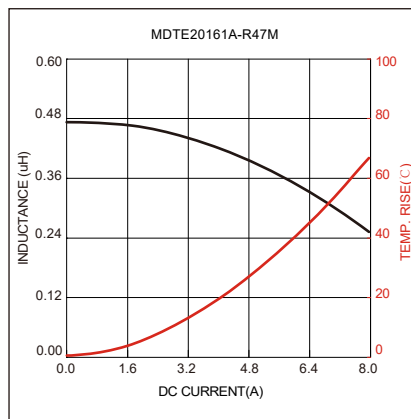
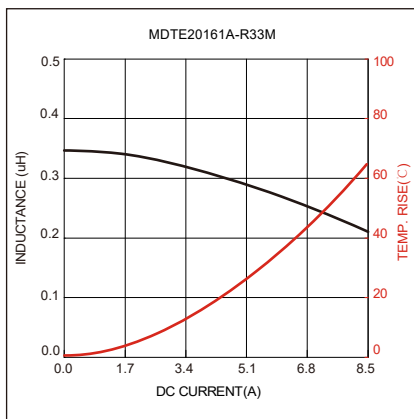
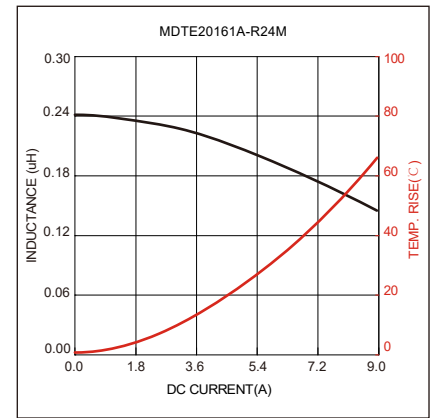
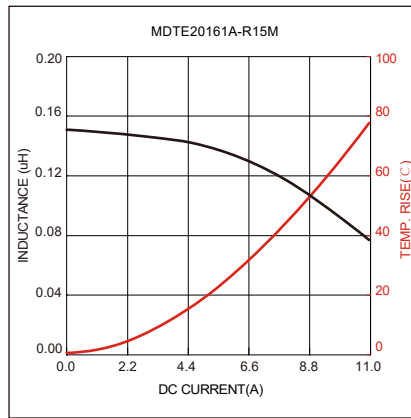
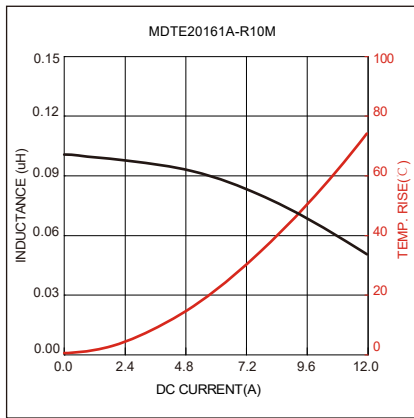

Soldering Reflow:

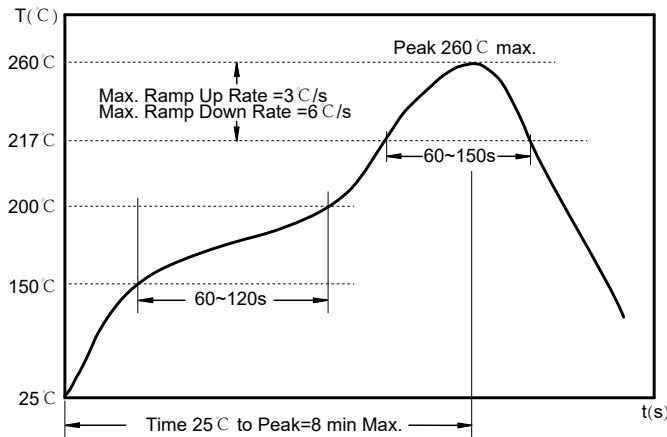

Preheat condition: 150 ~200°C / 60~120 sec.
 Allowed time above 217°C : 60~150 sec.
 Max temperature: 260°C.
 Allowed Reflow time: 2x max.

Packaging Information:

Tape Dimension:

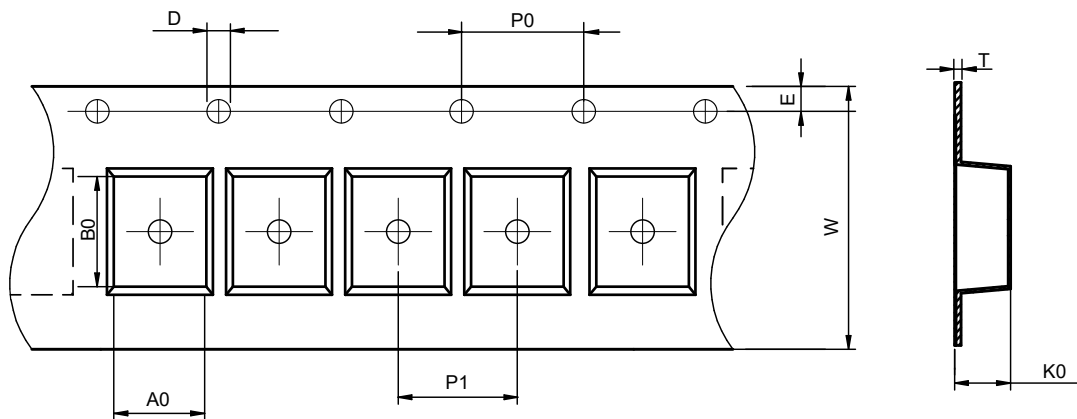

Series	A0 (mm)	B0 (mm)	D (mm)	P0 (mm)	P1 (mm)	W (mm)	K0 (mm)	E (mm)	T (mm)
MDTE20161A	1.9±0.1	2.3±0.1	1.5±0.1	4.0±0.1	4.0±0.1	8.0±0.1	1.2±0.1	1.75±0.1	0.25±0.05

Peel force of top cover tape:

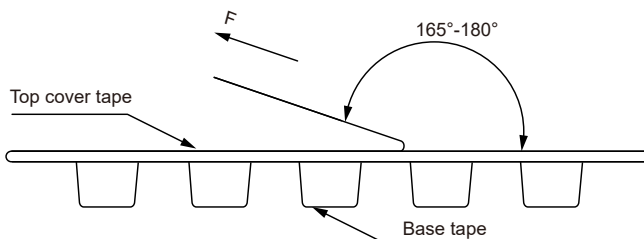

The peel force of top cover tape shall be between 0.1 to 0.98 N

Reel Dimension: [mm]

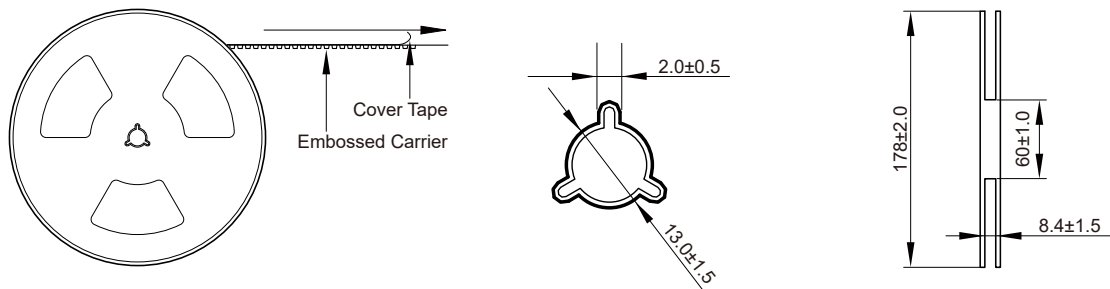

Packaging Quantity:

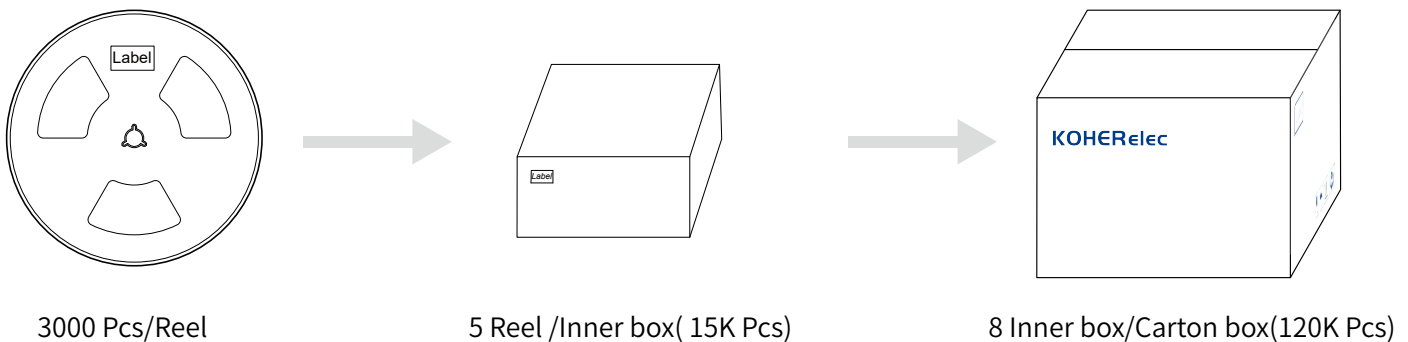

Cautions and Warnings:

Storage Conditions:

- The storage period is within 12 months after the completion of production. Be sure to follow the storage conditions (temperature: -5 to 35°C, humidity: 75% RH Max). If the storage period elapses, the soldering of the terminal electrodes may deteriorate. The warranty period is one year.
- Product should not be exposed to environment with high temperature, high humidity, dust, corrosive gas and etc.
- Products should be handled with care to avoid damage or contamination from perspiration and skin oils.
- Please always handle products carefully to prevent any damage caused by dropping down or inappropriate removing.

Operation Instructions:

- Self heating (temperature increase) occurs when the power is turned ON, so the tolerance should be sufficient for the set thermal design.
- Before soldering, be sure to preheat components. The preheating temperature should be set so that the temperature difference between the solder temperature and chip temperature does not exceed 150°C.
- Soldering corrections after mounting should be within the range of the conditions determined in the specifications. If overheated, a short circuit, performance deterioration, or lifespan shortening may occur.
- Generally, Koher might not be familiar with either customer's specific application or actual requests as customer does. As a result customer shall be responsible for checking and confirming whether Koher product with the performance described in the product specification is suitable for using in customer's particular application or not.